

BP-5039

Figure 1

Remove Lights & Any Parts On Top Of The Rear Of The Truck That Will Get In The Way Of Installing The Rear Light Bar. And Remember To Save The Original Screws Because It Go's Back On With The Light Bar.

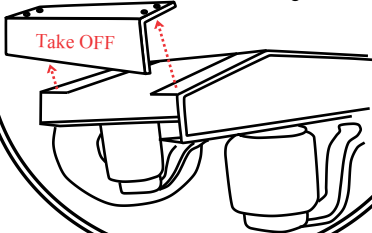

Figure 3

Put On The Supporting Brackets, & Tighten All Screws When Rear Frame Cover & The Light Bar Are In The Right Position Before Tightening All Screws Permanently

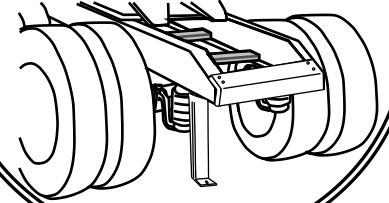

Figure 2

Put Rear Frame Cover & The Light Bar On The Back Of The Truck Loosely

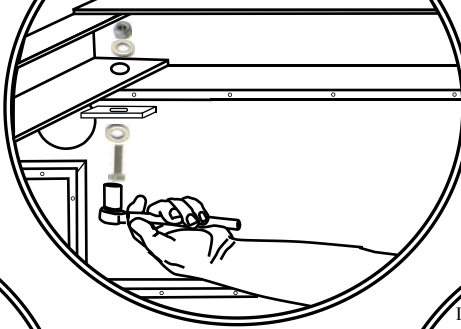

Figure 4

Once You Have The Rear Frame Cover, The Brackets & Light Bar Nice & Tighten You Can Now Put On The Back Plate But Remember To Connect The Lights First Before Doing So

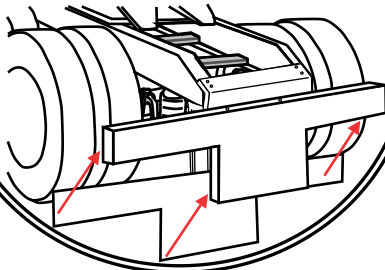
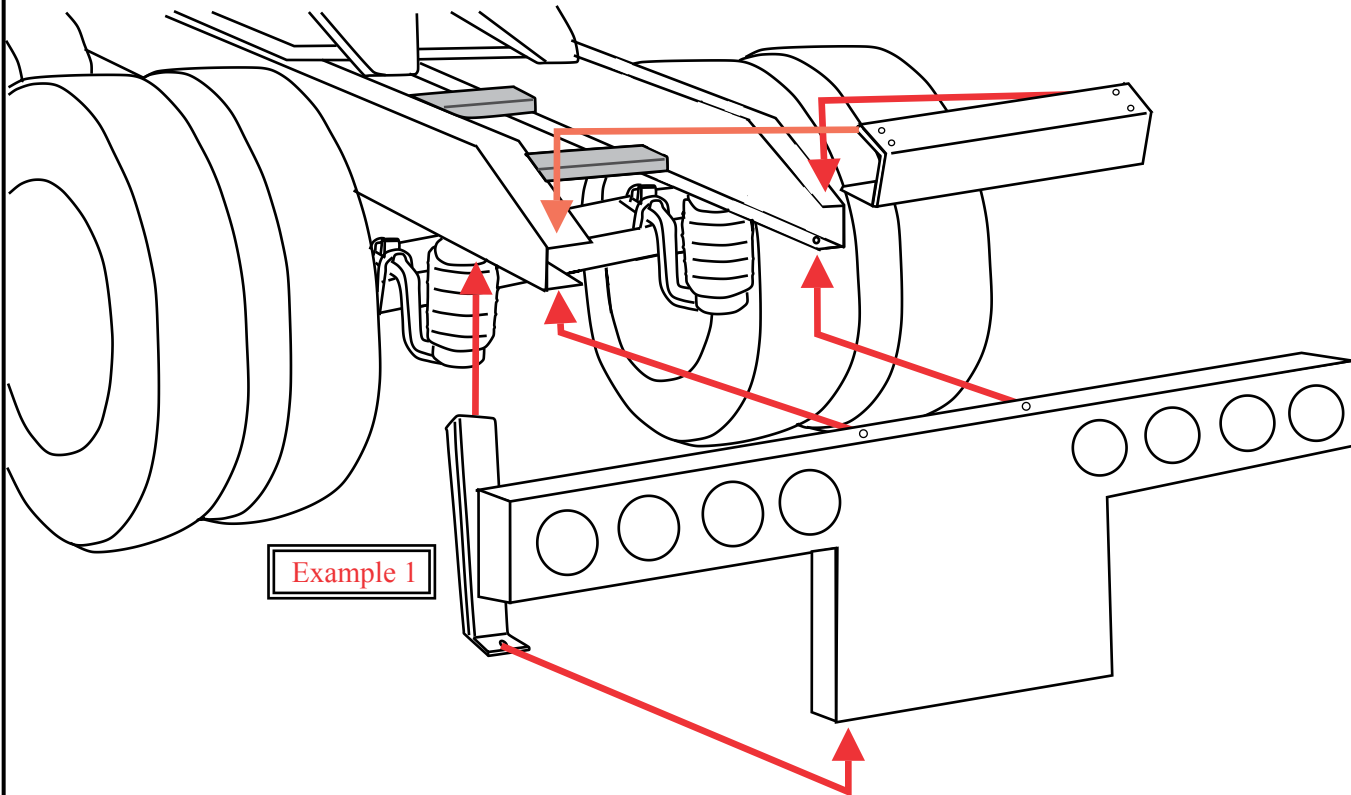
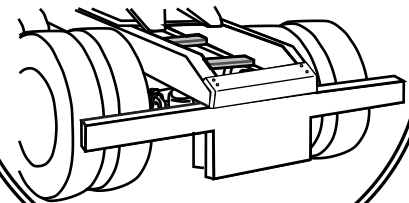





Figure 5

Now That You Are Finished With Installing Your ATA Rear Light Bar, Now Take Plastic Off The Light Bar & Clean With Windex



Example 1

Bolt Kit

	QTY: 1	Finished Hex Nut	1 1/2
	QTY: 7	Hex Head	1/2 - 13
	QTY: 8	Flat Washer	1/2